



36 860 670



- 140mm projection
- fixed spout
- rectangular, air-enriched flow
- hole diameter spout 37 mm
- hole diameter single-lever mixer 57 mm
- rosette for spout 80 x 60mm
- rosette for mixer 80 x 80mm
- max. flow 5.7 l/min
- lead-free
- This product can help a building meet the requirements of Green Building Rating Systems, e.g. LEED®, BREEAM®, DGNB

	Chrome	36 860 670-00
	Brushed Platinum	36 860 670-06
	Brushed Chrome	36 860 670-93

Required miscellaneous



Concealed wall-mounted single-lever mixer mixer on right - 35 816 970 90

- NOTE:Not suitable for concealed installation.Connection by means of angle valves, mounted with screws to back wall.

Required miscellaneous



Concealed wall-mounted single-lever mixer - 35 860 970 90

- max. recess depth 95 mm
- min. recess depth 80 mm

36 860 670

mm [inches]

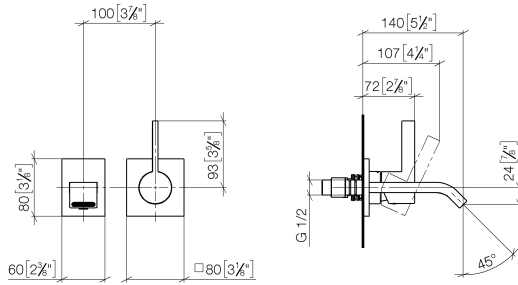

Flow rate chart



Certificates

LGA_29906.

DVGW_DW-
6512DN0435.

WRAS_2107018.

36 860 670

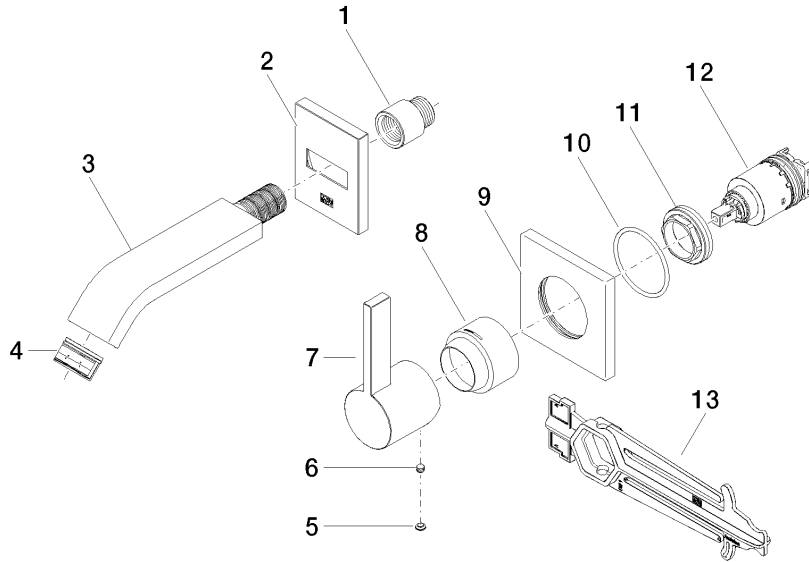

Spare parts list

No.	Item Number	Name	Quantity used	Delivery time
1	09 24 03 072 10 90	nipple	1	2
2	90 27 67 005 00-00	rosette	1	10
3	04 28 22 242 00-00	spout	1	10
4	90 29 03 109 00 90	aerator	1	2
5	90 31 20 087 00-00	plug	1	10
6	90 31 11 112 00 90	pin	1	2
7	09 20 67 004-00	handle	1	10
8	09 11 02 530-00	cover	1	10
9	09 27 78 039-00	rosette	1	10
10	90 14 10 049 00 90	seal	1	2
11	09 24 04 105 90	nut	1	2
12	90 15 05 064 01 90	cartridge	1	2
13	90 30 09 064 00 90	key	1	2